

GP1A91LCJ00F

Gap : 1.2mm, Slit : 0.23mm
*OPIC Output,
Compact Transmissive
Photointerrupter



■ Description

GP1A91LCJ00F is a compact-package, OPIC output, transmissive photointerrupter, with opposing emitter and detector in a molding that provides non-contact sensing. The compact package series is a result of unique technology combining transfer and injection molding.

This device has 2 positioning bosses on the detector side, open collector for the device's output.

■ Features

1. Transmissive with OPIC output
2. Highlights :
 - Compact Size
3. Key Parameters :
 - Gap Width : 1.2mm
 - Slit Width (detector side): 0.23mm
 - Package : 3.7×2.6×3.1mm
4. Lead free and RoHS directive compliant

■ Agency approvals/Compliance

1. Compliant with RoHS directive

■ Applications

1. Detection of object presence or motion.
2. Example : printer, lens control for camera

* "OPIC"(Optical IC) is a trademark of the SHARP Corporation. An OPIC consists of a light-detecting element and a signal-processing

Notice The content of data sheet is subject to change without prior notice.
In the absence of confirmation by device specification sheets, SHARP takes no responsibility for any defects that may occur in equipment using any SHARP devices shown in catalogs, data books, etc. Contact SHARP in order to obtain the latest device specification sheets before using any SHARP device.

Internal Connection Diagram

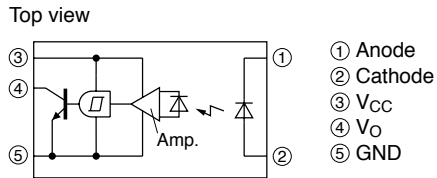

Outline Dimensions (Unit : mm)

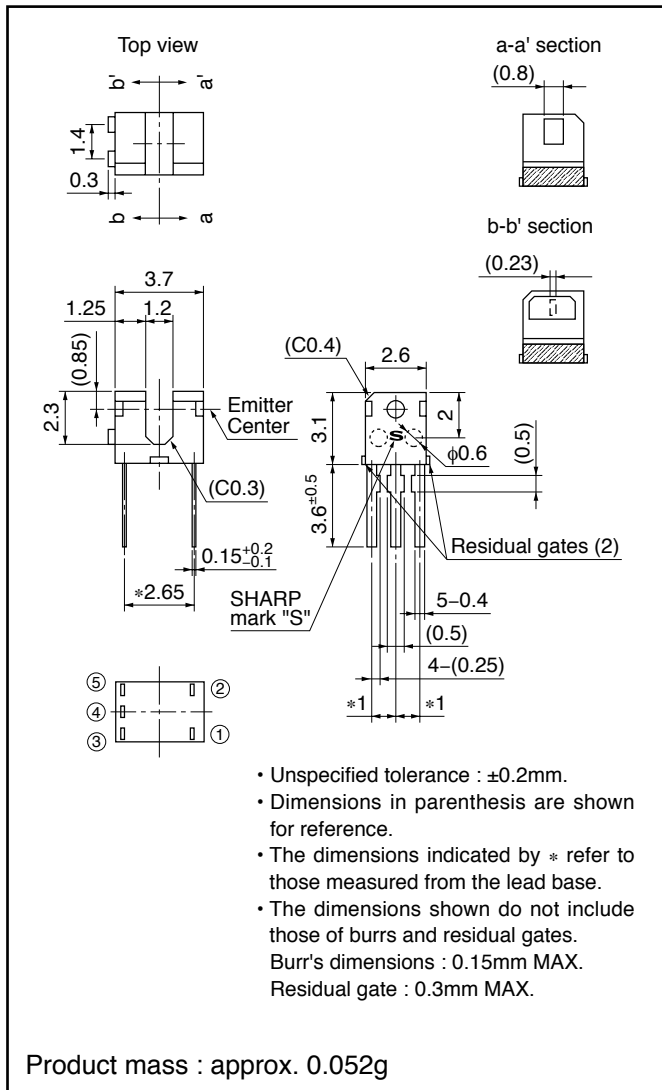

Plating material : SnCu (Cu : TYP. 2%)

Country of origin
Japan

■ Absolute Maximum Ratings (T_a=25°C)

Parameter		Symbol	Rating	Unit
Input	*1 Forward current	I _F	50	mA
	Reverse voltage	V _R	6	V
	Power dissipation	P	75	mW
Output	Supply voltage	V _{CC}	7	V
	*1 Out put current	I _O	2	mA
	*1 Power dissipation	P _O	80	mW
Operating temperature		T _{opr}	-25 to +85	°C
Storage temperature		T _{stg}	-40 to +100	°C
*2 Soldering temperature		T _{sol}	260	°C

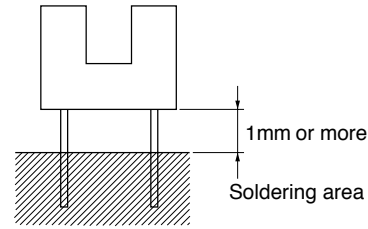

*1 Refer to Fig. 2, 3, 4.

*2 For 5s or less

■ Electro-optical Characteristics (T_a=25°C)

Parameter		Symbol	Condition	MIN.	TYP.	MAX.	Unit	
Input	Forward voltage	V _F	I _F =5mA	-	1.15	1.25	V	
	Reverse current	I _R	V _R =3V	-	-	10	μA	
Output	Operating supply voltage	V _{CC}	-	1.4	-	7	V	
	Low level output voltage	V _{OL}	V _{CC} =3V, I _{OL} =1mA, I _F =5mA	-	0.1	0.4	V	
	High level output voltage	V _{OH}	V _{CC} =3V, I _F =0	2.9	-	-	V	
	Low level supply current	I _{CCL}	V _{CC} =3V, I _F =5mA	-	0.7	1.2	mA	
	High level supply current	I _{CCH}	V _{CC} =3V, I _F =0	-	0.3	0.5	mA	
Transfer characteristics	*3 "High→Low" threshold input current	I _{FHL}	V _{CC} =3V	-	1.2	3.5	mA	
	*4 Hysteresis	I _{FLH} /I _{FHL}	V _{CC} =3V	0.55	0.8	0.95	-	
	Response time	"Low→High" Propagation delay time	t _{PLH}	V _{CE} =3V, I _F =5mA, R _L =2.4kΩ	-	10	30	μs
		"High→Low" Propagation delay time	t _{PHL}		-	3	15	
		Rise time	t _r		-	0.6	3	
		Fall time	t _f		-	0.2	1	

In order to measure the characteristics above except response time, connect a resistance R_L=15kΩ between V_{CC} and V_O.

*3 I_{FHL} represents forward current when output goes from "High" to "Low".

*4 I_{FLH} represents forward current when output goes from "Low" to "High".

Fig.1 Test Circuit for Response Time

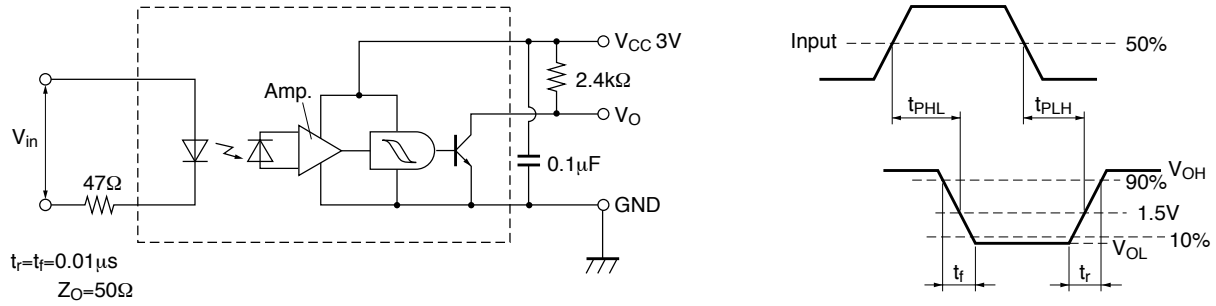

Fig.2 Forward Current vs. Ambient Temperature

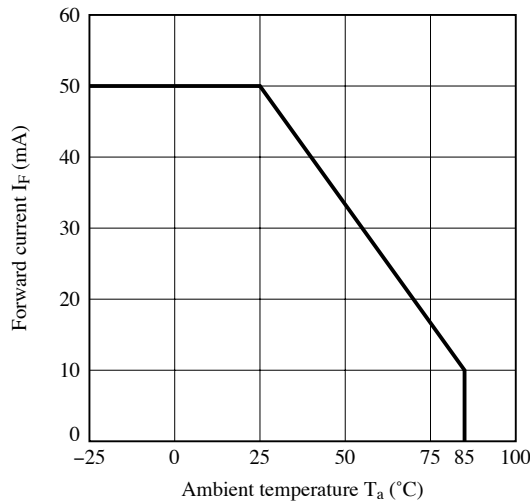

Fig.3 Output Current vs. Ambient Temperature

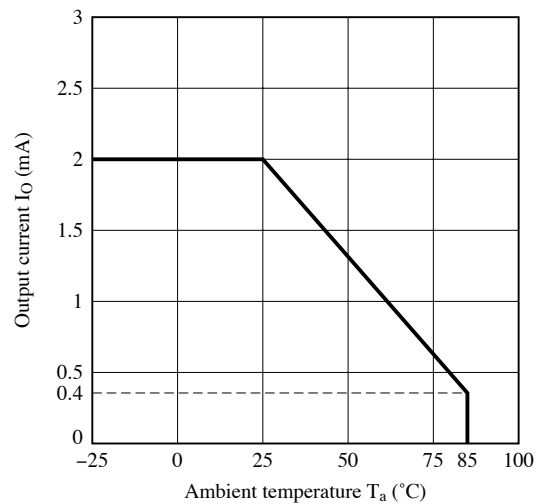

Fig.4 Output Power Dissipation vs. Ambient Temperature

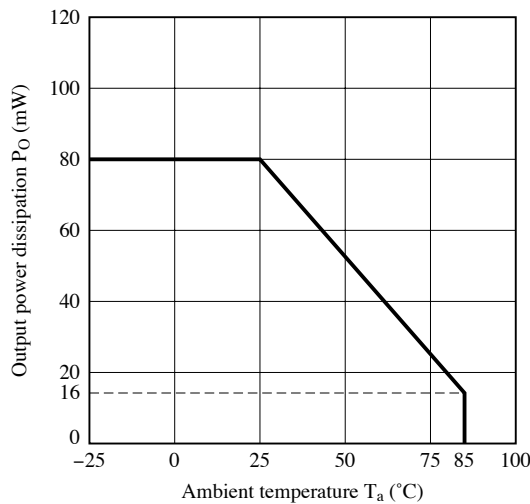

Fig.5 Forward Current vs. Forward Voltage

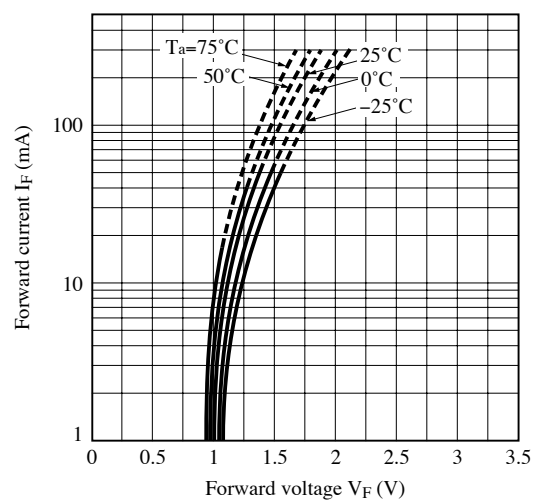

Fig.6 Relative Threshold Input Current vs. Supply Voltage

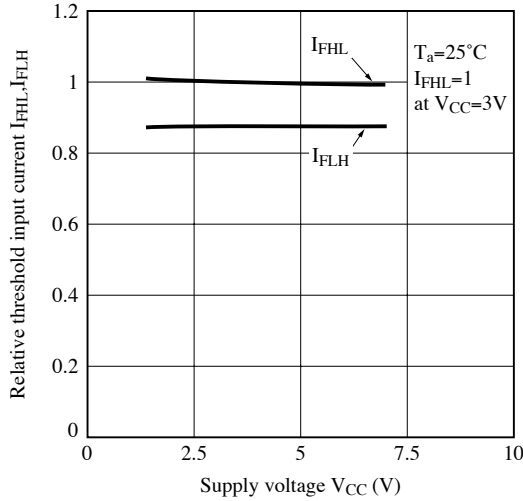

Fig.7 Relative Threshold Input Current vs. Ambient Temperature

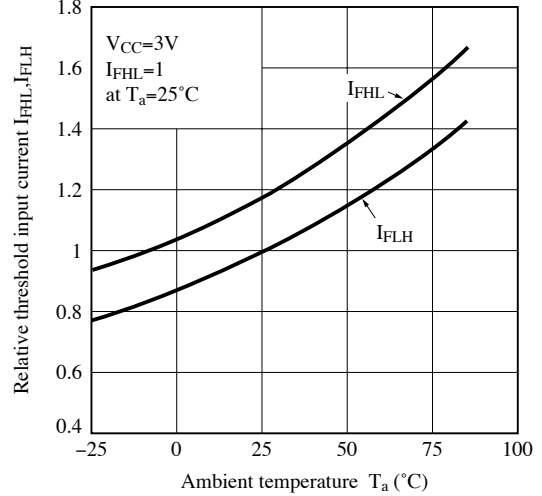

Fig.8 Low Level, High Level Supply Current vs. Supply Voltage (1)

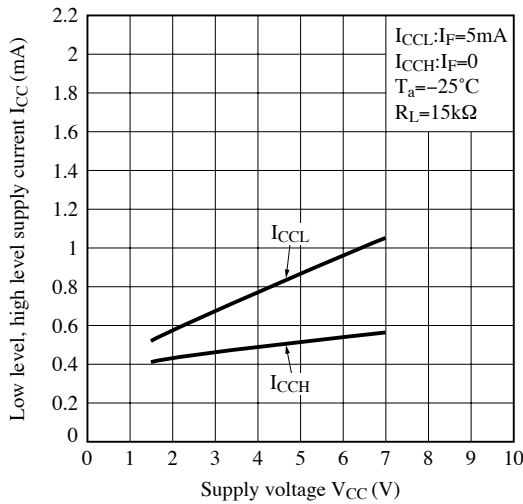

Fig.9 Low Level, High Level Supply Current vs. Supply Voltage (2)

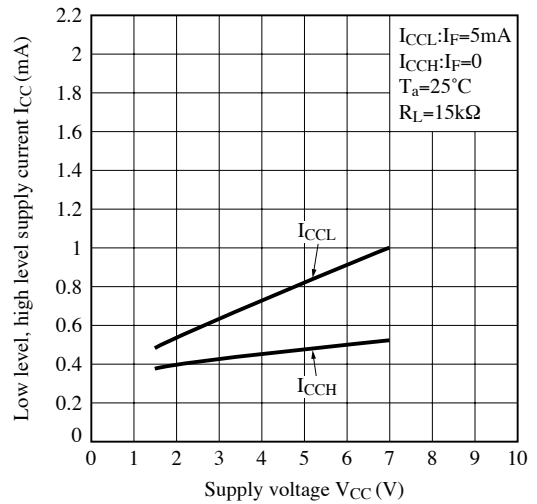

Fig.10 Low Level, High Level Supply Current vs. Supply Voltage (3)

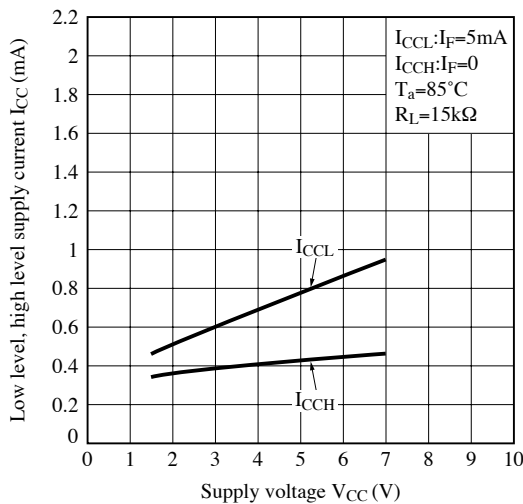

Fig.11 Low Level Output Voltage vs. Low Level Output Current

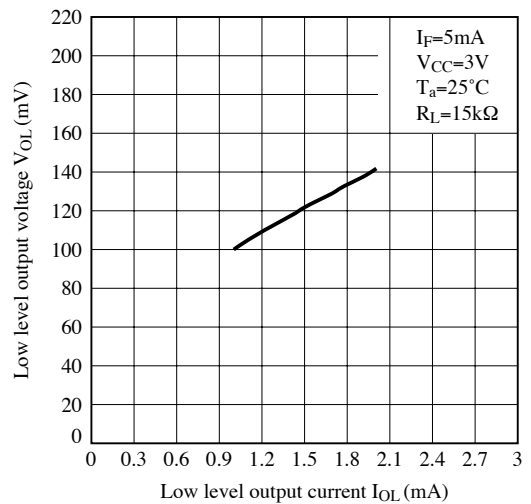

Fig.12 Low Level Output Voltage vs. Ambient Temperature

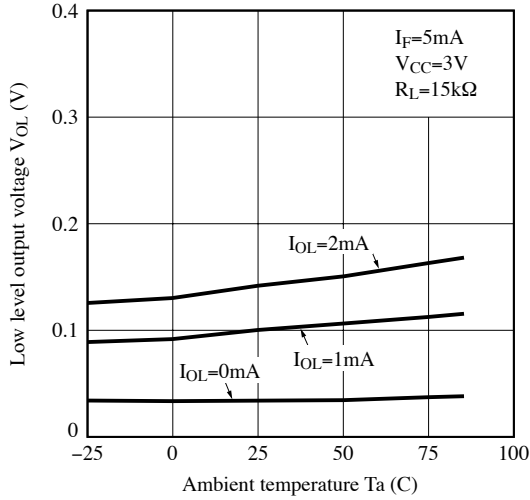

Fig.13 Rise Time, Fall Time vs. Load Resistance

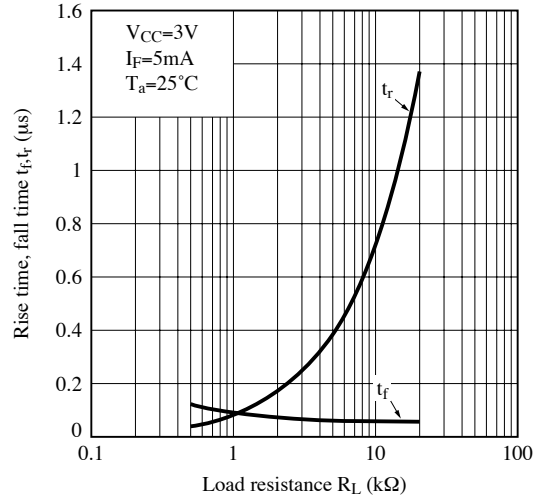

Fig.14 Propagation Delay Time vs. Forward Current

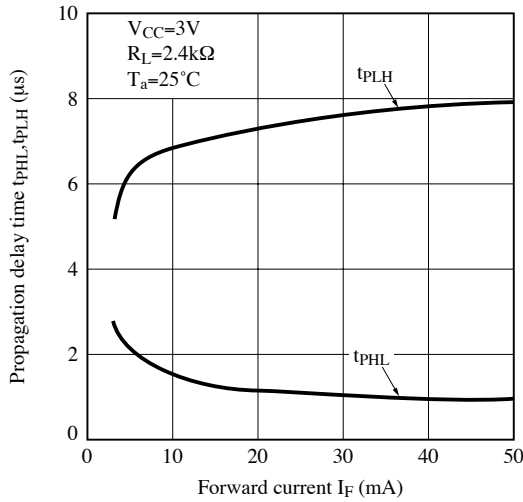

Fig.15 Low, High Level Output vs. Shield Distance (1) (Typical Value)

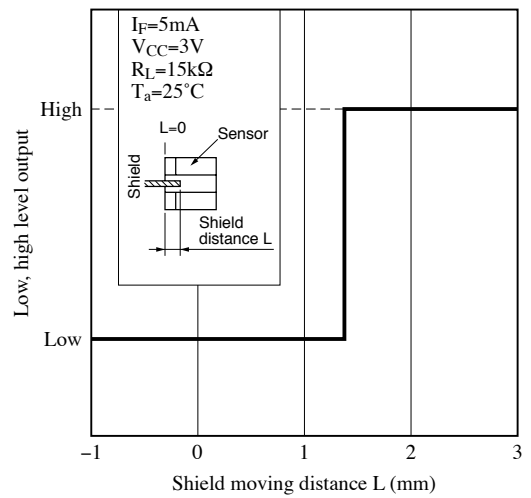
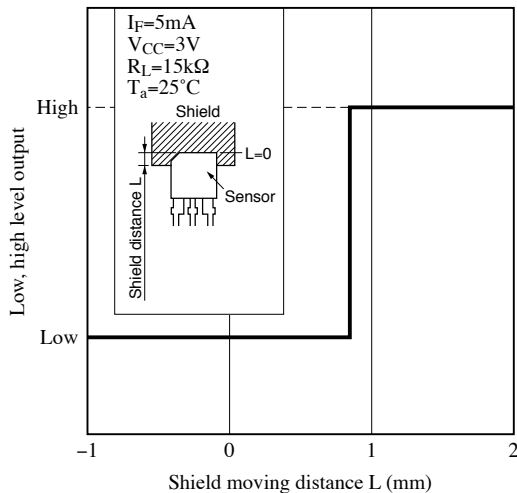

Fig.16 Low, High Level Output vs. Shield Distance (2) (Typical Value)



Remarks : Please be aware that all data in the graph are just for reference and not for guarantee.

■ **Design Considerations**

● **Design guide**

1) Prevention of detection error

To prevent photointerrupter from faulty operation caused by external light, do not set the detecting face to the external light.

2) Position of opaque board

Opaque board shall be installed at place 1.6mm or more from the top of elements.

(Example)

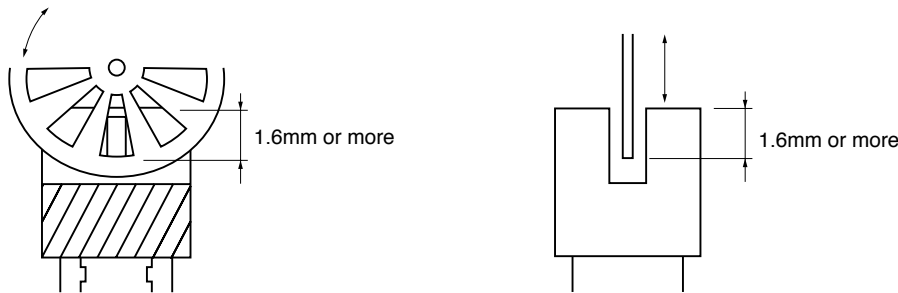

This product is not designed against irradiation and incorporates non-coherent IRED.

● **Degradation**

In general, the emission of the IRED used in photointerrupter will degrade over time.

In the case of long term operation, please take the general IRED degradation (50% degradation over 5 years) into the design consideration.

Please decide the input current which become 2 times of MAX. I_{FHL} .

● **Parts**

This product is assembled using the below parts.

• **Photodetector (qty. : 1)** [Using a silicon photodiode as light detecting portion, and a bipolar IC as signal processing circuit]

Category	Material	Maximum Sensitivity wavelength (nm)	Sensitivity wavelength (nm)	Response time (μs)
Photo diode	Silicon (Si)	900	700 to 1 200	3

• **Photo emitter (qty. : 1)**

Category	Material	Maximum light emitting wavelength (nm)	I/O Frequency (MHz)
Infrared emitting diode (non-coherent)	Gallium arsenide (GaAs)	950	0.3

- Material

Case	Lead frame	Lead frame plating
Black polyphernylene sulfide resin (UL94 V-0)	42Alloy	SnCu plating

- Others

Laser generator is not used.

■ Manufacturing Guidelines**● Soldering Method**

Flow Soldering:

Soldering should be completed below 260°C and within 5 s.

Please solder within one time.

Soldering area is 1 mm or more away from the bottom of housing.

Please take care not to let any external force exert on lead pins.

Please don't do soldering with preheating, and please don't do soldering by reflow.

Hand soldering

Hand soldering should be completed within 3 s when the point of solder iron is below 350°C.

Please solder within one time.

Please don't touch the terminals directly by soldering iron.

Soldered product shall treat at normal temperature.

Other notice

Please test the soldering method in actual condition and make sure the soldering works fine, since the impact on the junction between the device and PCB varies depending on the cooling and soldering conditions.

● Cleaning instructions

Solvent cleaning :

Solvent temperature should be 45°C or below. Immersion time should be 3 minutes or less.

Ultrasonic cleaning :

Do not execute ultrasonic cleaning.

Recommended solvent materials :

Ethyl alcohol, Methyl alcohol and Isopropyl alcohol.

● Presence of ODC

This product shall not contain the following materials.

And they are not used in the production process for this product.

Regulation substances : CFCs, Halon, Carbon tetrachloride, 1.1.1-Trichloroethane (Methylchloroform)

Specific brominated flame retardants such as the PBBOs and PBBs are not used in this product at all.

This product shall not contain the following materials banned in the RoHS Directive (2002/95/EC).

•Lead, Mercury, Cadmium, Hexavalent chromium, Polybrominated biphenyls (PBB), Polybrominated diphenyl ethers (PBDE).

■ Package specification**● Sleeve package**

Package materials

Sleeve : Polystyrene

Stopper : Styrene-Elastomer

Package method

MAX. 100 pcs. of products shall be packaged in a sleeve. Both ends shall be closed by tabbed and tabless stoppers.

MAX. 50 sleeves in one case.

■ Important Notices

· The circuit application examples in this publication are provided to explain representative applications of SHARP devices and are not intended to guarantee any circuit design or license any intellectual property rights. SHARP takes no responsibility for any problems related to any intellectual property right of a third party resulting from the use of SHARP's devices.

· Contact SHARP in order to obtain the latest device specification sheets before using any SHARP device. SHARP reserves the right to make changes in the specifications, characteristics, data, materials, structure, and other contents described herein at any time without notice in order to improve design or reliability. Manufacturing locations are also subject to change without notice.

· Observe the following points when using any devices in this publication. SHARP takes no responsibility for damage caused by improper use of the devices which does not meet the conditions and absolute maximum ratings to be used specified in the relevant specification sheet nor meet the following conditions:

(i) The devices in this publication are designed for use in general electronic equipment designs such as:

- Personal computers
- Office automation equipment
- Telecommunication equipment [terminal]
- Test and measurement equipment
- Industrial control
- Audio visual equipment
- Consumer electronics

(ii) Measures such as fail-safe function and redundant design should be taken to ensure reliability and safety when SHARP devices are used for or in connection

with equipment that requires higher reliability such as:

- Transportation control and safety equipment (i.e., aircraft, trains, automobiles, etc.)
- Traffic signals
- Gas leakage sensor breakers
- Alarm equipment
- Various safety devices, etc.

(iii) SHARP devices shall not be used for or in connection with equipment that requires an extremely high level of reliability and safety such as:

- Space applications
- Telecommunication equipment [trunk lines]
- Nuclear power control equipment
- Medical and other life support equipment (e.g., scuba).

· If the SHARP devices listed in this publication fall within the scope of strategic products described in the Foreign Exchange and Foreign Trade Law of Japan, it is necessary to obtain approval to export such SHARP devices.

· This publication is the proprietary product of SHARP and is copyrighted, with all rights reserved. Under the copyright laws, no part of this publication may be reproduced or transmitted in any form or by any means, electronic or mechanical, for any purpose, in whole or in part, without the express written permission of SHARP. Express written permission is also required before any use of this publication may be made by a third party.

· Contact and consult with a SHARP representative if there are any questions about the contents of this publication.